

FIXED COUPLER FIXED MULLION OPERABLE MULLION FIXED JAMB OPERABLE JAMB FIXED SILL OPERABLE SILL

300A
SERIES

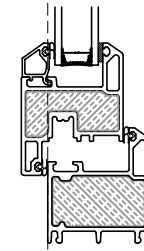

300
SERIES

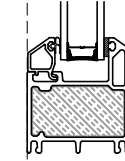
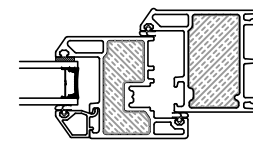
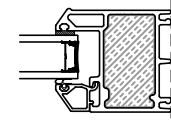
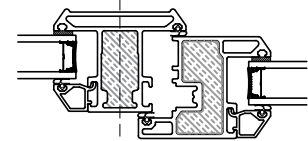
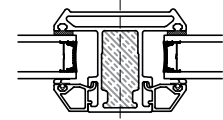
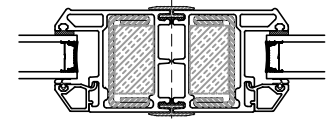
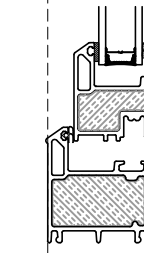
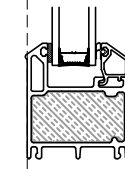
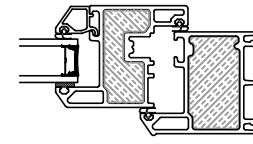
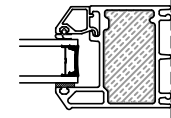
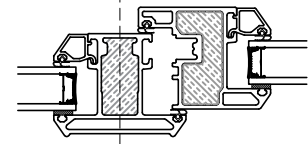
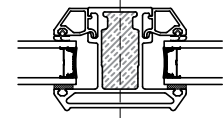
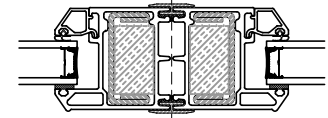

400/300A
SERIES

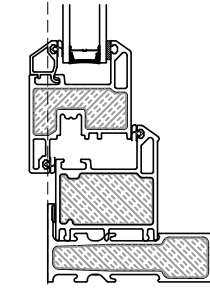
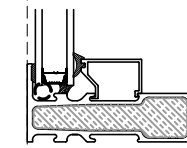
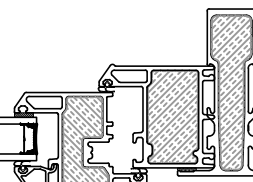
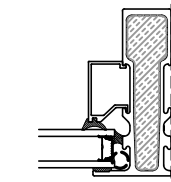
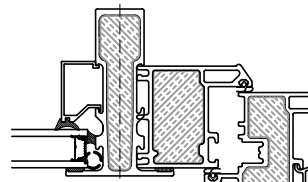
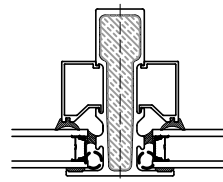
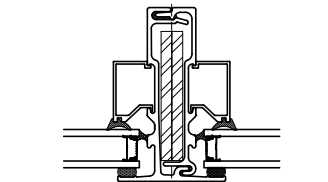

400/300
SERIES

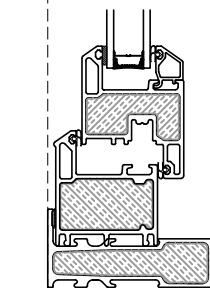
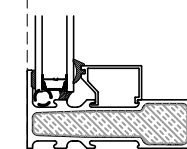
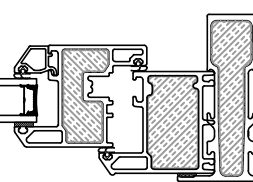
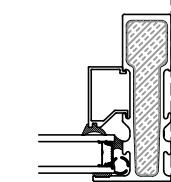
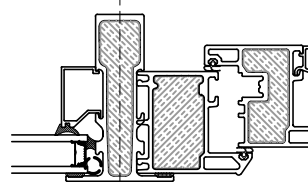
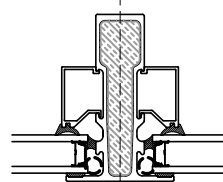
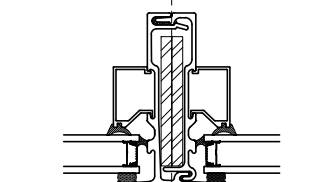

400/325
SERIES

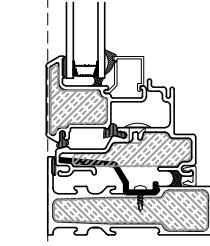
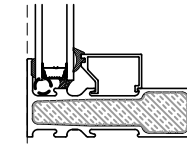
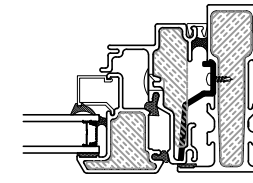
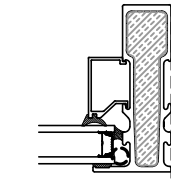
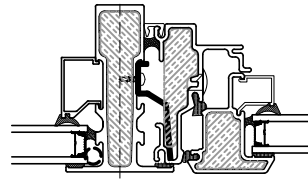
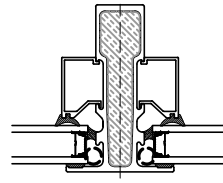
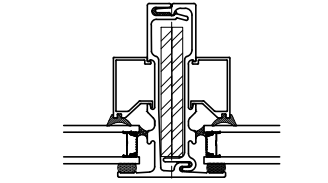

UNIVERSAL
SERIES
OUTSWING

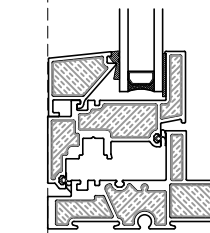
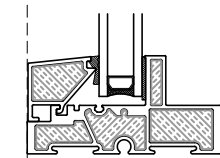
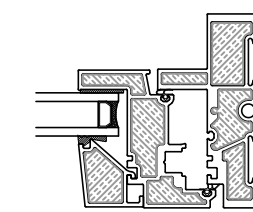
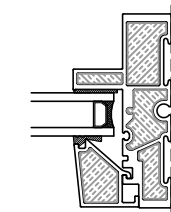
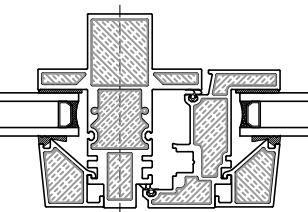
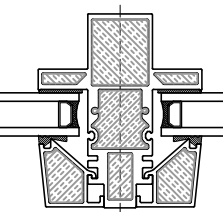
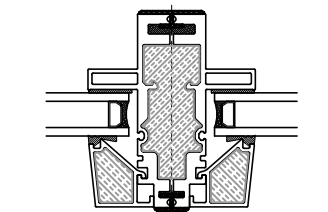

**CASCADIA
WINDOWS LTD.**

27950 GLOUCESTER WAY
LANGLEY, BC CANDA V4W 3Y5
604-857-4600

PROJECT TITLE:
**WINDOW
BROCHURE**

ISSUE	DESCRIPTION	DATE
1	1ST SUBMITAL	DEC.12/16

DRAWING
TITLE:
**WINDOW
ELEVATIONS**

SCALE: N.T.S.	DRAWING NO.:
DATE: DEC 12/16	1.1
DRAWN BY: CP	
PROJECT #: XXXX	



**CASCADIA
WINDOWS LTD.**

27950 GLOUCESTER WAY
LANGLEY, BC CANADA V4W 3Y5
604-857-4600

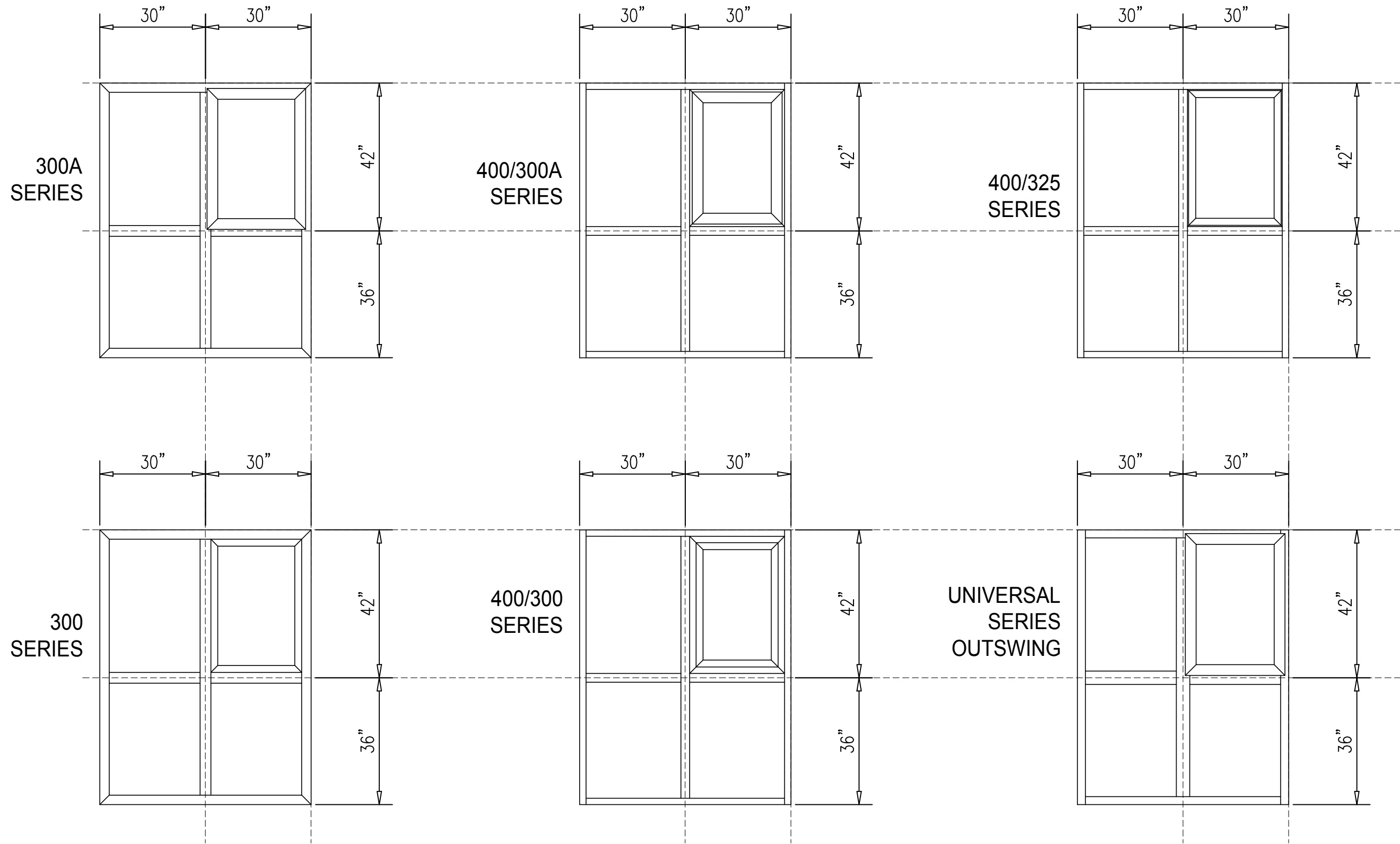

PROJECT TITLE:
**WINDOW
BROCHURE**

ISSUE	DESCRIPTION	DATE
1	1ST SUBMITTAL	DEC.12/16

DRAWING TITLE:
**WINDOW
ELEVATIONS**

SCALE: **N.T.S.** DRAWING NO.:
DATE: **DEC 12/16** **1.2**
DRAWN BY: **CP**
PROJECT #: **XXXX**

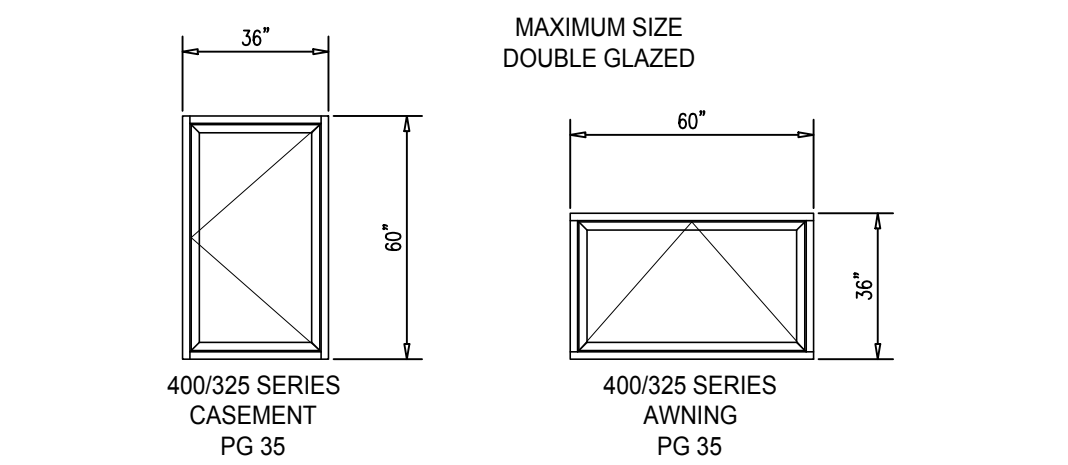
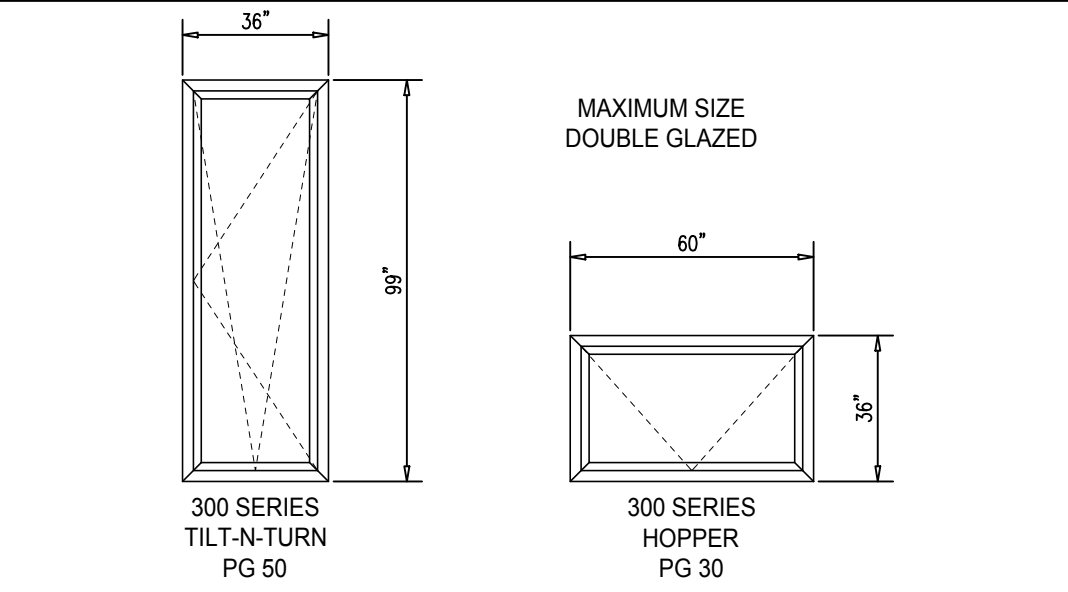
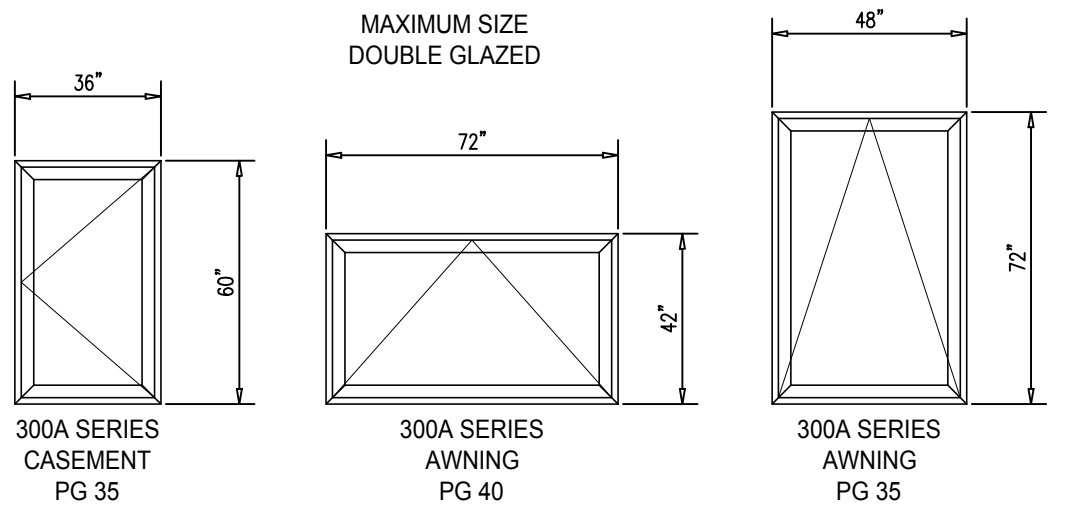
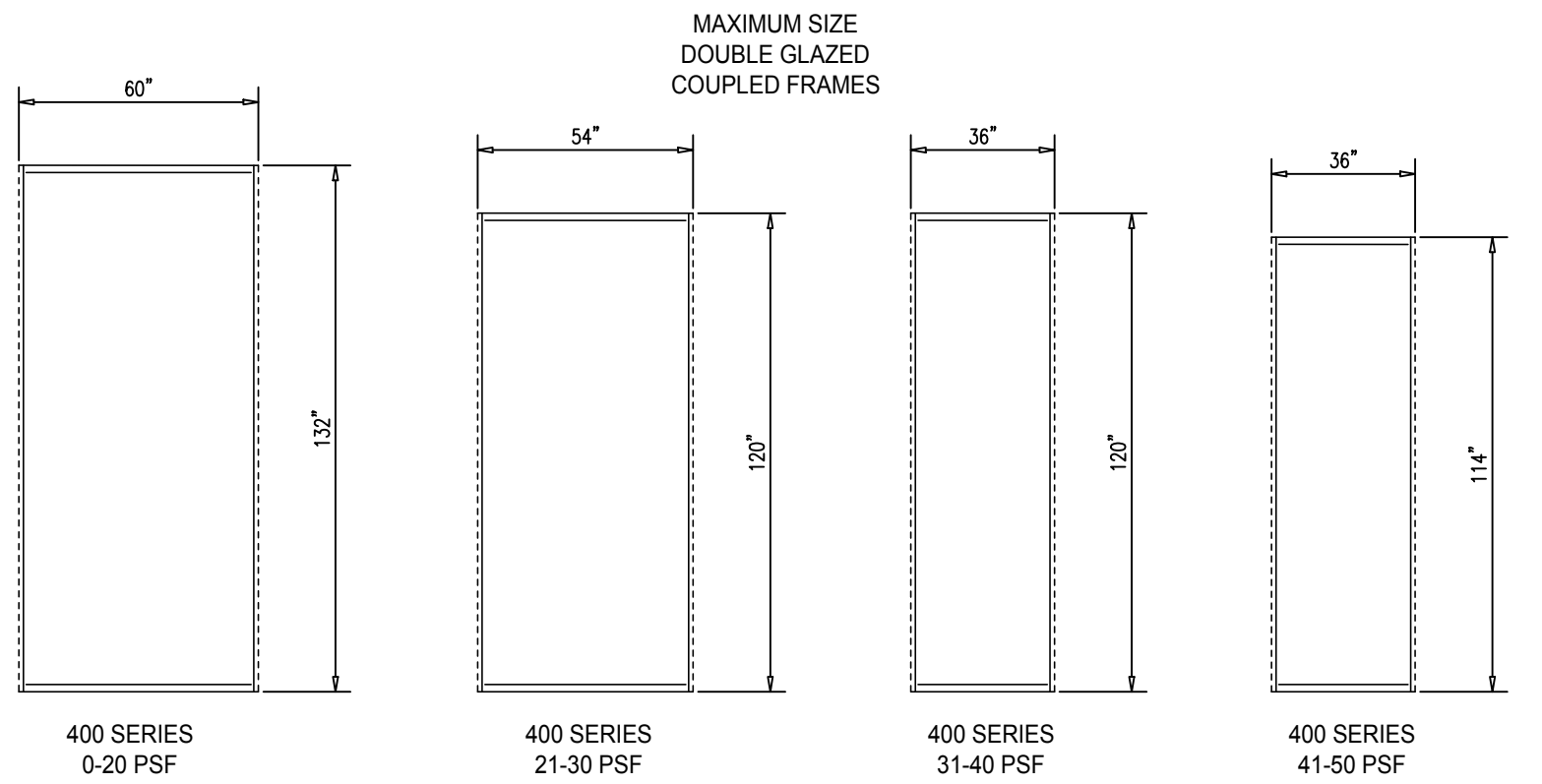
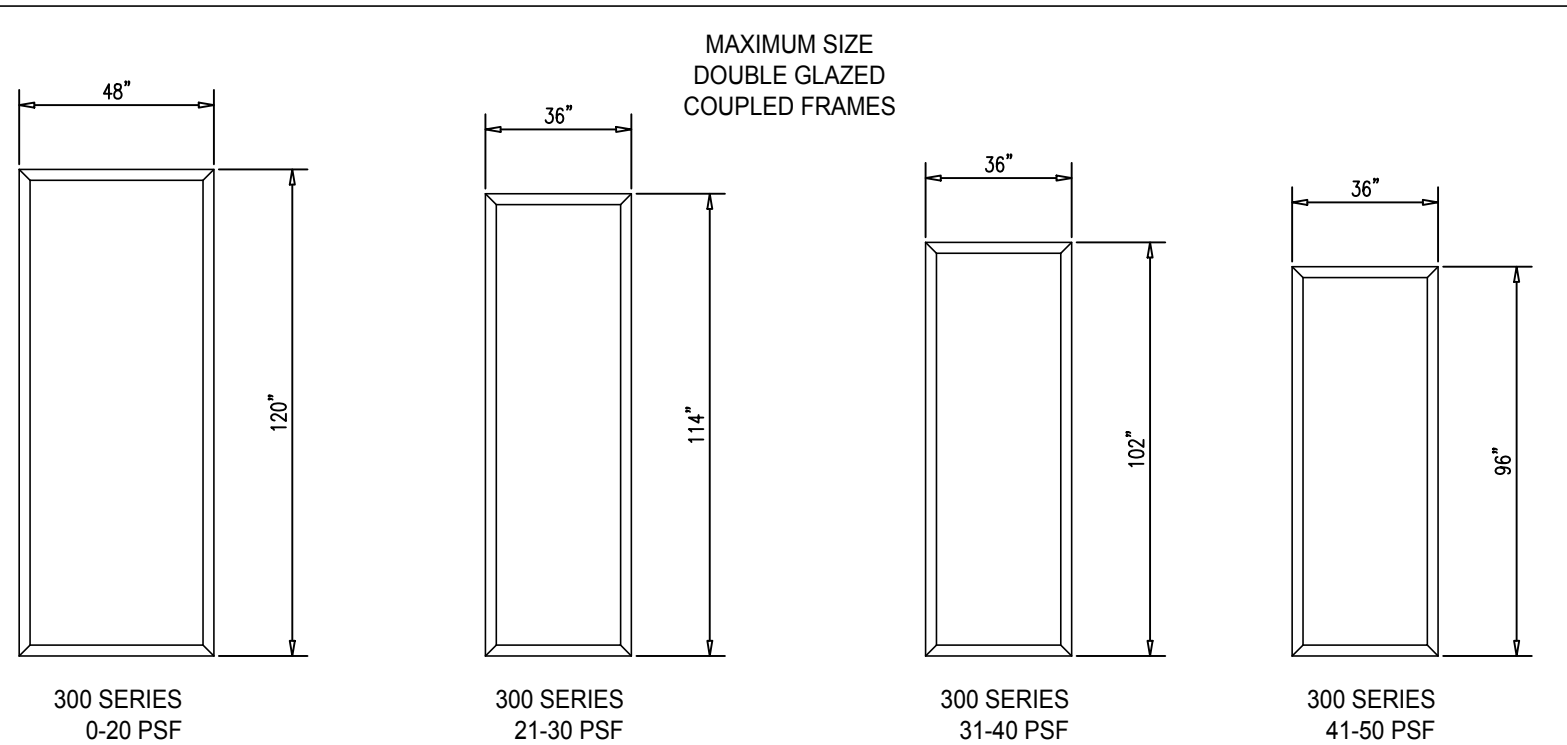

**CASCADIA
WINDOWS LTD.**
27950 GLOUCESTER WAY
LANGLEY, BC CANDA V4W 3Y5
604-857-4600

PROJECT TITLE:
**WINDOW
BROCHURE**

ISSUE	DESCRIPTION	DATE
1	1ST SUBMITAL	DEC.12/16

DRAWING TITLE:
**WINDOW
ELEVATIONS**

SCALE: **N.T.S.** DRAWING NO.:
DATE: **DEC 12/16** **1.3**
DRAWN BY: **CP**
PROJECT#: **XXXX**

400 SERIES
41-50 PSF
36" x 114"

400 SERIES
31-40 PSF
36" x 120"

400 SERIES
21-30 PSF
54" x 120"

400 SERIES
0-20 PSF
60" x 132"

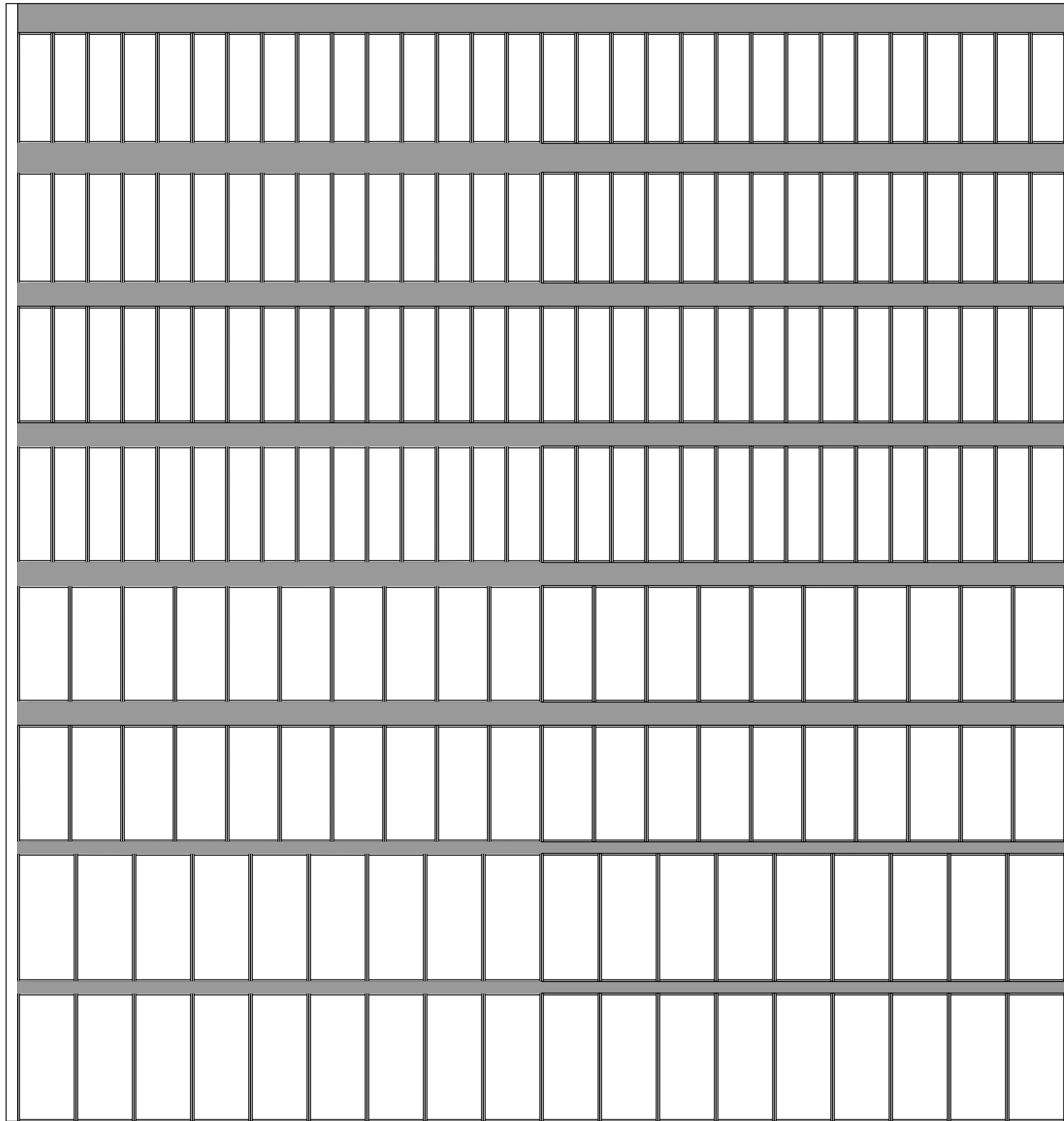

CASCADIA
WINDOWS LTD.

27950 GLOUCESTER WAY
LANGLEY, BC CANDA V4W 3Y5
604-857-4600

PROJECT TITLE:
**WINDOW
BROCHURE**

ISSUE	DESCRIPTION	DATE
1	1ST SUBMITAL	DEC.12/16

DRAWING
TITLE:
**WINDOW
ELEVATIONS**

SCALE: **N.T.S.** DRAWING NO.:
DATE: **DEC 12/16** **1.4**
DRAWN BY: **CP**
PROJECT#: **XXXX**